



landscape • entertainment • architectural • hospitality • illumination

# SL-17 STEP LIGHTS



25301 COMMERCENTRE DRIVE • LAKE FOREST, CA 92630 • 949.830.1350 • 888.882.1350 • FAX 949.830.3390



# STEP LIGHTS SL-17 12 VOLT SERIES



TYPE

## SPECIFICATIONS

### CONSTRUCTION:

FACE PLATE: Cast aluminum or brass  
 BACK BOX: Aluminum models- Cast aluminum powder coated high reflective white  
 Brass models- Unfinished cast brass

**LENS SL-17:** Clear tempered flat glass

**LENS SL-17-AL:** White acrylic lens

**LENS SL-17-ALMR16 MODELS:** Linear spread glass lens

**GASKET:** Black neosponge closed cell; .190" thickness

**LAMP SUPPLIED:** 18w S8 #1141; 1200 hours average rating (25w max.)

**LAMP SUPPLIED -MR16 MODELS:** 20w MR16 FL(BAB); 5000 hours rating (20w max.)

**LAMP OPTIONS:** We recommend 3w 50,000 hours average rating OMNI-3 LED (-LED3) or OMNI-3 Super Saver (-LED3SS) or 10,000 hours average rating Xenon (-X) or Halogen (-H)

**LAMP OPTIONS -MR16 MODELS:** We recommend ARROW 4w 50,000 hour LED (-LED) or 5w or 7w 40,000 hour ARROW SUPER SAVER LED (-LED5/LED7);

**SOCKET:** Single contact bayonet, brass nickel plated lamp socket screw shell (Ba15s) with 200°C silicone lead wires

**SOCKET -MR16 MODELS:** High temp ceramic GU5.3 bi-pin with 250°C silicone lead wires

**WIRING:** Black 3 foot 18/2 zip cord (12v only)

For 25 foot 16/2 fixture lead wire add -25F to catalog number.

**CONNECTION:** FA-05 Quick Connector (not supplied) from fixture to main cable (12/2, 10/2 or 8/2 only)

**FINISH:** Aluminum - Black texture polyester powder coat. Optional finishes available  
 Brass - Unfinished. Optional finishes available

**NOTE:** 1/2" end holes for feed through available. Specify at time of order.



SL-17-BRS



SL-17-AL-BAV

## ORDERING INFORMATION

CATALOG NO.	DESCRIPTION	LAMP	SHIP WEIGHT
SL-17-BLT	Cast Aluminum 3 Louver Step Light	18w S8 #1141	2.0 lbs.
SL-17-BRS	Cast Brass 3 Louver Step Light	18w S8 #1141	4.0 lbs.
SL-17-AL-BLT	Cast Aluminum Lensed Step Light	18w S8 #1141	2.0 lbs.
SL-17-AL-BRS	Cast Brass Lensed Step Light	18w S8 #1141	4.0 lbs.
SL-17-AL-MR16-BLT	Cast Aluminum Lensed Step Light	20w MR16 FL(BAB)	2.0 lbs.
SL-17-AL-MR16-BRS	Cast Brass Lensed Step Light	20w MR16 FL(BAB)	4.0 lbs.

## FACE PLATE ONLY

CATALOG NO.	DESCRIPTION
FA-47-BLT	12v Cast Aluminum 3 Louver Face Plate
FA-47-BRS	12v Cast Brass 3 Louver Face Plate
FA-48-BLT	12v Cast Aluminum Lensed Face Plate, White Acrylic Lens
FA-48-BRS	12v Cast Brass Lensed Face Plate, White Acrylic Lens
FA-48-MR16-BLT	12v Cast Aluminum Lensed Face Plate, Linear Spread Lens
FA-48-MR16-BRS	12v Cast Brass Lensed Face Plate, Linear Spread Lens

## BACK BOX/SOCKET/LAMP ONLY

CATALOG NO.	DESCRIPTION	LAMP
FA-65	Cast Aluminum back box with lamp and socket	18w S8 #1141
FA-65-H	Cast Aluminum back box with lamp and socket	20w halogen SC
FA-65-X	Cast Aluminum back box with lamp and socket	20w xenon SC
FA-65-MR16	Cast Aluminum back box with lamp and socket	20w MR16 FL(BAB)
FA-65-NL	Cast Aluminum back box with socket	None, Ba15s socket
FA-65-BRS	Cast Brass back box with lamp and socket	18w S8 #1141
FA-65-H-BRS	Cast Brass back box with lamp and socket	20w halogen SC
FA-65-X-BRS	Cast Brass back box with lamp and socket	20w xenon SC
FA-65-MR16-BRS	Cast Brass back box with lamp and socket	20w MR16 FL(BAB)
FA-65-NL-BRS	Cast Brass back box with socket	None, Ba15s socket

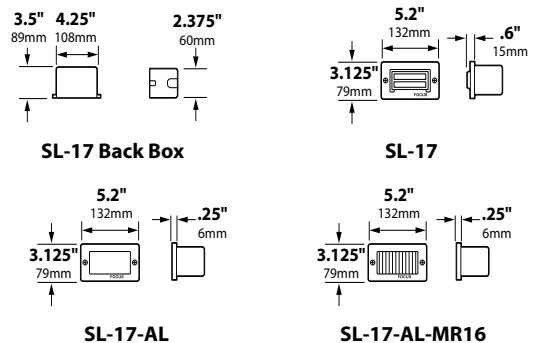

SL-17: Mounting Holes on all models 4-1/2" on center



## JOB INFORMATION

Type: \_\_\_\_\_ Date: \_\_\_\_\_

Job Name: \_\_\_\_\_

Cat. No.: \_\_\_\_\_

Lamp(s): \_\_\_\_\_

Specifier: \_\_\_\_\_

Contractor: \_\_\_\_\_

Notes: \_\_\_\_\_

FOCUS INDUSTRIES INC.  
 25301 COMMERCENTRE DRIVE  
 LAKE FOREST, CA 92630  
 www.focusindustries.com  
 sales@focusindustries.com  
 (949) 830-1350 • FAX (949) 830-3390

Black Texture (Standard)	Antique Verde	Bronze Texture	Camel	White Texture	Hunter Texture	Rust	Weathered Iron	Weathered Brown	Stucco	Rubbed Verde	Chrome Powder	Acid Rust	Acid Verde	Black Acid Treatment
-BLT	-ATV	-BRT	-CAM	-WTX	-HTX	-RST	-WIR	-WBR	-STU	-RBV	-CPR	-BAR/CAR	-BAV/CAV	-BAT



# STEP LIGHTS SL-17 12 VOLT SERIES

## LIGHTING DISTRIBUTIONS AND PHOTOMETRICS

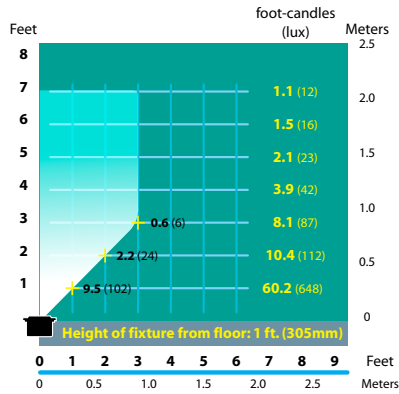

SL-17 Half Spread Photometrics

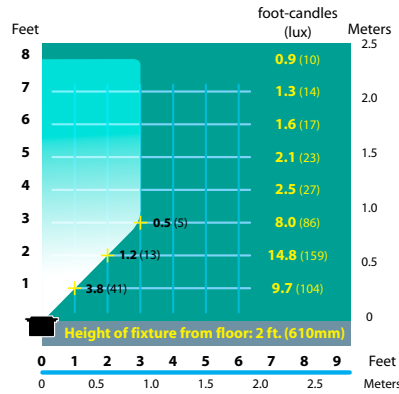

SL-17 Half Spread Photometrics

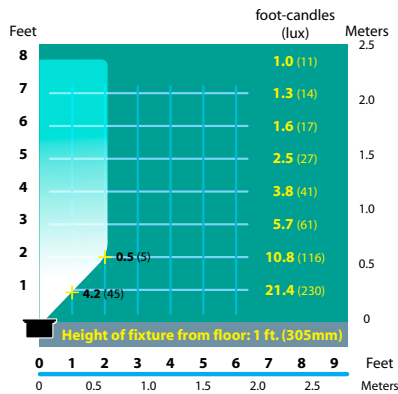

SL-17-AL Half Spread Photometrics

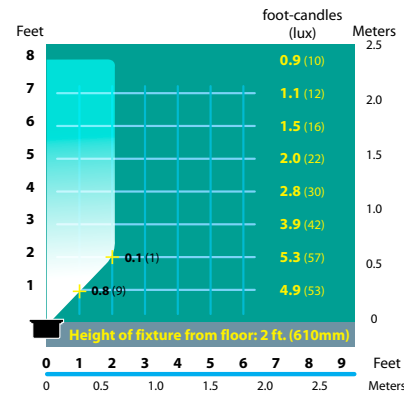

SL-17-AL Half Spread Photometrics

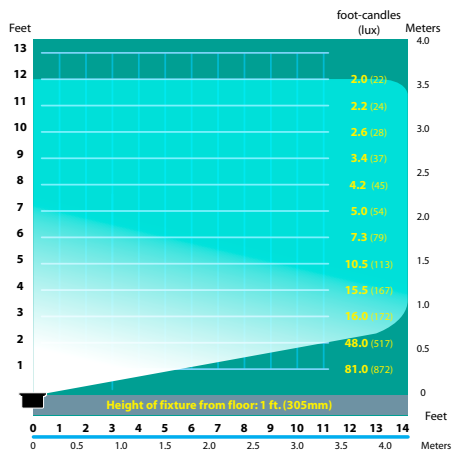

SL-17-AL-MR16 Half Spread Photometrics (20w)

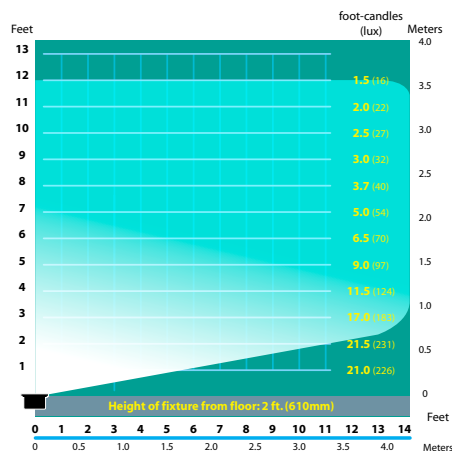

SL-17-AL-MR16 Half Spread Photometrics (20w)

Black Texture (Standard)	Antique Verde	Bronze Texture	Camel	White Texture	Hunter Texture	Rust	Weathered Iron	Weathered Brown	Stucco	Rubbed Verde	Chrome Powder	Terra Cotta	Acid Rust	Acid Verde	Black Acid Treatment
-BLT	-ATV	-BRT	-CAM	-WTX	-HTX	-RST	-WIR	-WBR	-STU	-RBV	-CPR	-TRC	-BAR/CAR	-BAV/CAV	-BAT

BRASS & COPPER ONLY